



# TrueView GO

User Manual







# Table of Contents

<b>Table of Contents</b> .....	<b>2</b>
<b>1 Reading Tips</b> .....	<b>3</b>
1.1 Symbol Descriptions.....	3
1.2 Recommendations .....	3
1.3 Service & Support .....	3
1.4 Disclaimer.....	3
<b>2 Using Requirements</b> .....	<b>4</b>
2.1 Using Environment.....	4
2.2 Tips Before Use .....	4
2.3 Tips During Use .....	4
2.4 Tips After Using.....	4
<b>3 Product Description</b> .....	<b>5</b>
3.1 Check List .....	5
3.2 Delivery of Equipment and Materials .....	6
3.3 Physical Characteristics .....	8
3.3.1 Weight and Size.....	8
3.3.2 Interface Definition .....	9
3.4 Power Supply and Physical Characteristics .....	9
<b>4 Product Workflow</b> .....	<b>10</b>
4.1 Advance Preparation.....	10
4.2 TrueView GO APP Control .....	10
4.2.1 WiFi connection .....	10
4.2.2 RTK settings .....	11
4.2.3 Start project .....	12
4.2.4 Select capture scene .....	12
4.2.5 Device initialization .....	13
4.2.6 Start data acquisition .....	14
4.2.7 Add control point .....	14
4.2.8 Stop data acquisition.....	15
4.3 One-Key control .....	16
4.4 Hot-swapping battery.....	17
<b>5 Data preprocessing</b> .....	<b>17</b>
5.1 Data copy .....	17
5.2 Open LP360 Land.....	<b>Error! Bookmark not defined.</b>
<b>6 Matters Needing Attention</b> .....	<b>27</b>
6.1 Important Notes.....	26
6.2 Product Transportation .....	26
6.3 Usage Tips .....	26
6.4 Storage Tips.....	27

Reading Tips

## 1.1 Symbol Description

-  **Forbid**
-  **Warning**
-  **Important note**
-  **Operate & Using tips**

## 1.2 Recommendations

GeoCue provides below documents for users:

- TrueView GO Surveying System user manual
- TrueView GO Configuration list

It is recommended for users to read the above documents before using for the first time.

If users have any questions regarding the content of this manual, please contact us at 1-256-461-8289 for professional consultation and assistance.

## 1.3 Service & Support

GEOCUE website: [www.GeoCue.com](http://www.GeoCue.com)

Email: [support@GeoCue.com](mailto:support@GeoCue.com)

Tel: 1-256-461-8289

GeoCue reserves the right to modify product status and user manuals without prior notice.

For the latest product information, please visit GeoCue's official website ([www.GeoCue.com](http://www.GeoCue.com)).

## 1.4 Disclaimer

- The customer must use and maintain the equipment according to the guidelines provided in this manual. GeoCue will not be responsible for any damage or reduced service life caused by improper use or maintenance. Any repairs and maintenance services required as a result of such issues will be charged at standard rates.
- GeoCue will not be responsible for any damage to the equipment that occurs due to improper handling during transportation.
- GeoCue will not be responsible for any damage that occurs if the customer disassembles or reassembles the equipment without GeoCue's authorization or recommendations.
- Customers should use only the default batteries and accessories. The use of non-original accessories voids the warranty, and the manufacturer will not be responsible for any accidents

that occur as a result.

## **2 Using Requirements**

### **2.1 Using Environment**

- It is not recommended to use the equipment in rainy, snowy, or foggy weather for safety reasons. Additionally, using the equipment in these conditions may result in point cloud data with increased noise.
- It is not recommended to frequently use the equipment in dusty environments, as this can affect its service life.
- Additionally, it is not recommended to expose the device and accessories to extreme temperatures. The operating environment temperature must be within the specified range to avoid damage.

### **2.2 Tips Before Use**

- Check the condition of the laser glass. If there is any dust present, use the cleaning kit to clean it.
- Ensure that the batteries and the LT800 tablet have sufficient power.

### **2.3 Tips During Use**

- After powering on, verify that the connection between the LT800 tablet and the equipment is functioning correctly, and that the status of the tracking satellite and board is normal.
- Before starting work, check the remaining capacity of the data memory card. If the remaining capacity is less than 10% or does not meet the current collection capacity requirements, delete old data files in advance.

### **2.4 Tips After Use**

- After use, place the equipment in its designated case and store the accessories in the accessory case.
- During transportation, handle the equipment with care and avoid any bumps or impacts.

## 3 Product Description

Explore more with TrueView GO: now offering Handheld Scanning in two versions, 116S and 132S. GeoCue brings the latest in handheld scanning technology with the TrueView GO product range. By combining traditional GNSS RTK surveying with cutting-edge 3D reality capture, it not only simplifies field operations but also significantly enhances the reliability and quality of the data collected. The TrueView GO is your ultimate tool for flexible, accurate surveying, capable of scanning indoor, outdoor, and subterranean environments, making complex scanning tasks as simple as walking through your site.

### 3.1 Check List

**Note: Please refer to the actual delivery list.**

TRUEVIEW GO Handheld Mapping System configuration list is shown below:

N	Description	Model	Pcs
1	TRUEVIEW GO unit	TRUEVIEW GO	1
2	TRUEVIEW GO handle		1
3	Load-bearing pad		1
4	TRUEVIEW GO transport container		1
5	USB3.0 to TYPE-C adapter cable		1
6	Lens cleaning wipes		10
7	32 GB USB flash disk		1
8	TrueView GO software		1
9	TRUEVIEW GO Factory Test Certificate		1
10	Notice Card		1
11	TRUEVIEW GO SLAM permanent license		1
12	TrueView accessories (include tablet & tablet clamp)		1
13	Chest support bracket		1
14	TRUEVIEW GO Battery (3300mAh)	3300mAh	3
15	Battery charger (C300)	C300	1

## 3.2 Delivery of Equipment and Materials

Note: Please refer to the actual delivery list.



- TrueView GO with handle:



- TrueView GO with chest support bracket:



- TrueView GO with handle, load-bearing pad:



- TrueView GO with Tablet, Tablet clamp:



- TrueView GO Tablet, Tablet clamp:



- Battery (3300mAh):



- Battery charger (C300):



- Lens cleaning wipes:



### 3.3 Physical Characteristics

#### 3.3.1 Weight and Size

- Weight: 1.9 kg (including RTK and battery).
- Length, width, and height (213.5×126×178mm) are shown below:

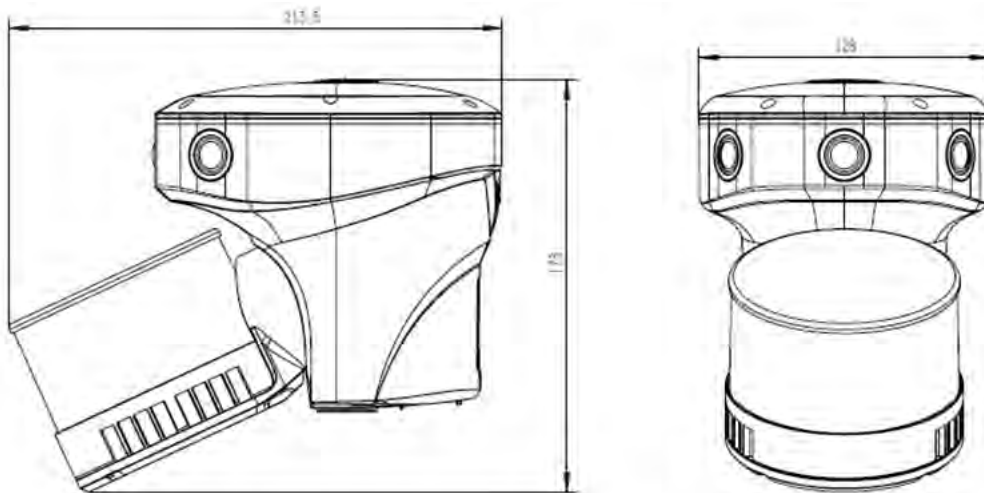



### 3.3.2 Interface Definition

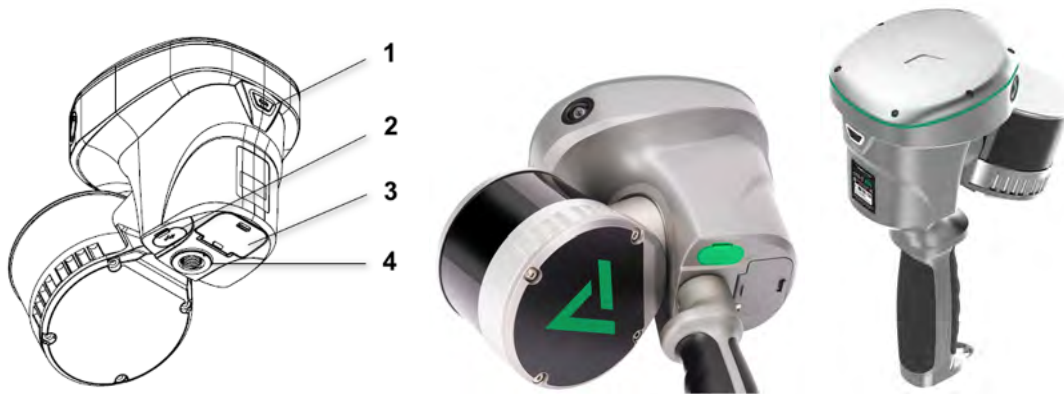

1. Turn on/off button
2. Type-C port for data copy
3. Battery compartment
4. Handle/ Range pole hole

LED indicator	Device status
red and green lights flash alternately at 1hz frequency	FW Upgrading...
device automatically restarts after green light are steady on	FW Upgraded successfully
the green light flashing rapidly at 2Hz	Device diagnostics
green light is steady on	Device ready
green light blinks at 0.5hz	Collecting...
red light is steady on	Error
red light blinks every 5 seconds	Low battery

### 3.4 Power Supply and Physical Characteristics

Input voltage	9-20V DC
Power consumption	< 30W
Operating temperature	-20 °C to +50 °C
Storage temperature	-20 °C to +60 °C

## 4 Product Workflow

For user convenience, two methods of data collection are provided: TrueView GO App Control and One-Key Control.

### 4.1 Advance Preparation

- Check the equipment to ensure that the contents and other accessories are not missing.
- Check for any smudges on the laser beam exit window and camera. If smudges are present, use the cleaning tools provided in the package to gently wipe and clean them.
- Make sure the batteries and LT800 tablet are fully charged.
- Check the device authorization and storage space.

### 4.2 TrueView GO APP Control

#### 4.2.1 WiFi connection

- Click “WiFi name” to search device Wi-Fi (SLAM-XXXXX, XXXXX is the same as the last five characters of the device SN), click “Connect to device” to connect the device to the tablet via Wi-Fi.

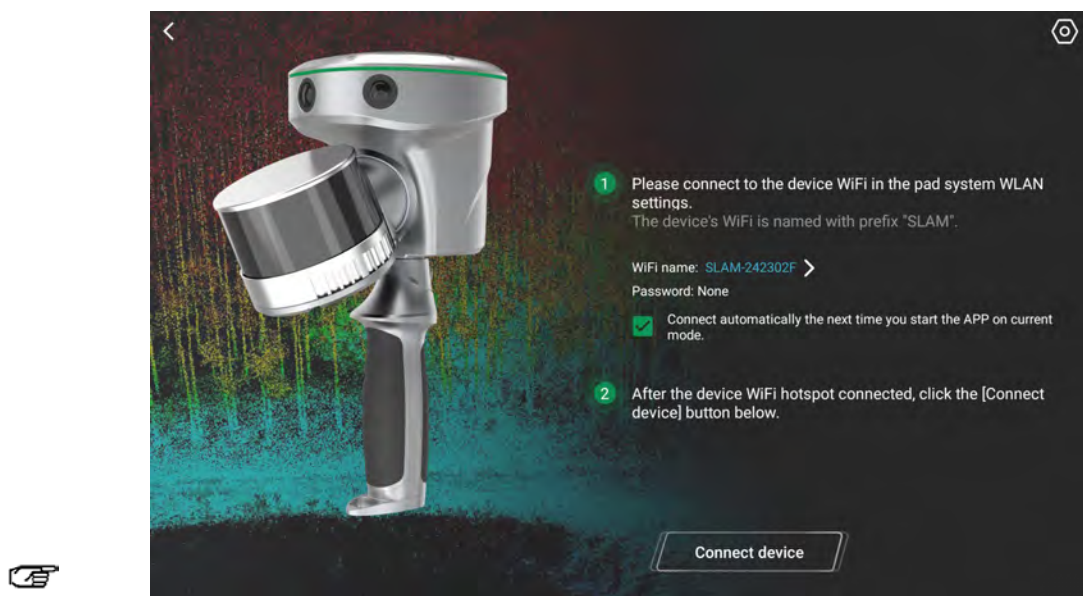

**Note: Make sure your tablet's connected to the device's WiFi and that no other apps are using that connection.**

- Click “Start capture” to enter the data collection interface, shown as below.

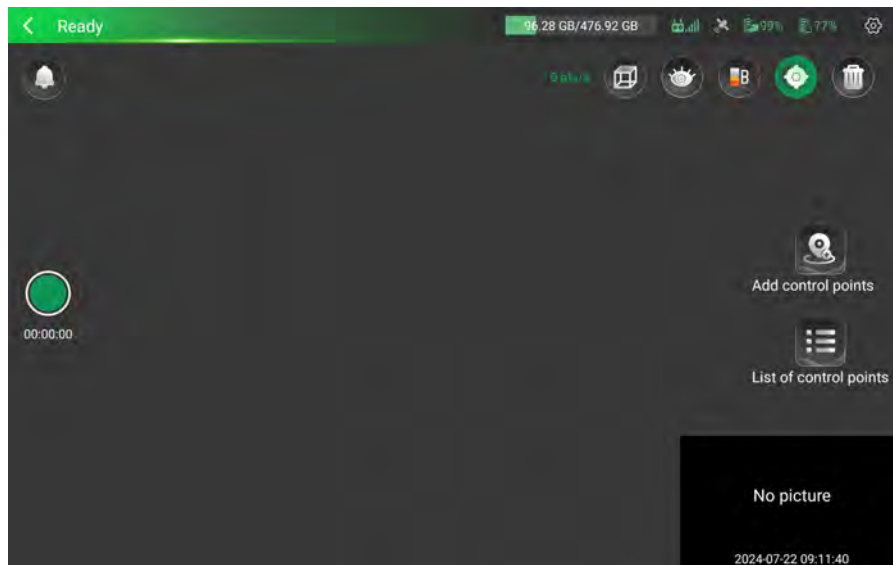

## 4.2.2 RTK settings

- You can output real-time point cloud data with absolute coordinates either by logging into the CORS account in the RTK settings or through PPK. We’ve tested the T-Mobile SIM Card for optimized results.

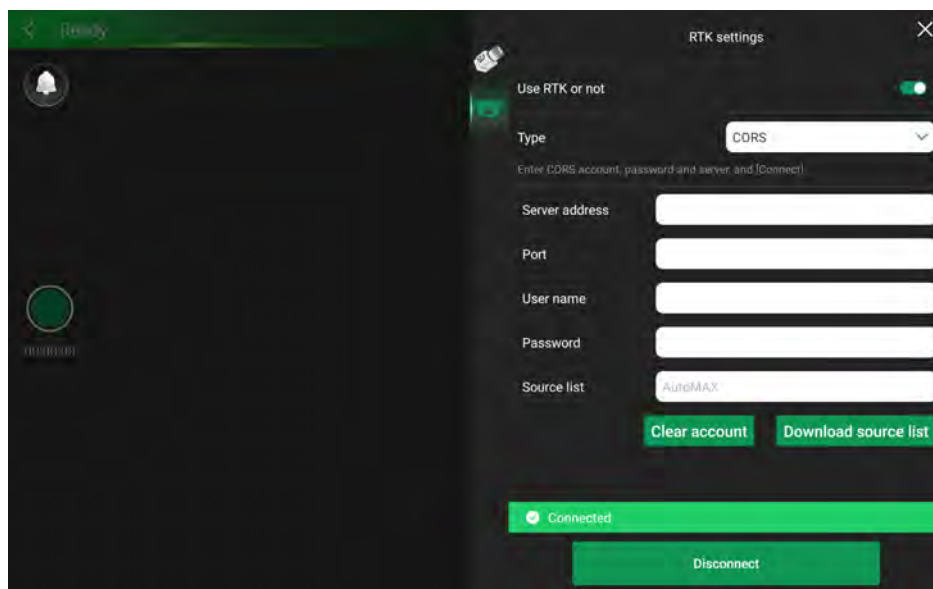

**Note:**

When logging into CORS, there are a couple of things to keep in mind.

- First, make sure your port settings align with your coordinate system outcomes.
- Second, avoid logging in with the same account on multiple devices simultaneously. Doing

so can cause account conflicts and disconnections.

### 4.2.3 Start project

- Click on the green circular button on the left side of the screen to start a project. Remember, project names must be written in letters or numbers.

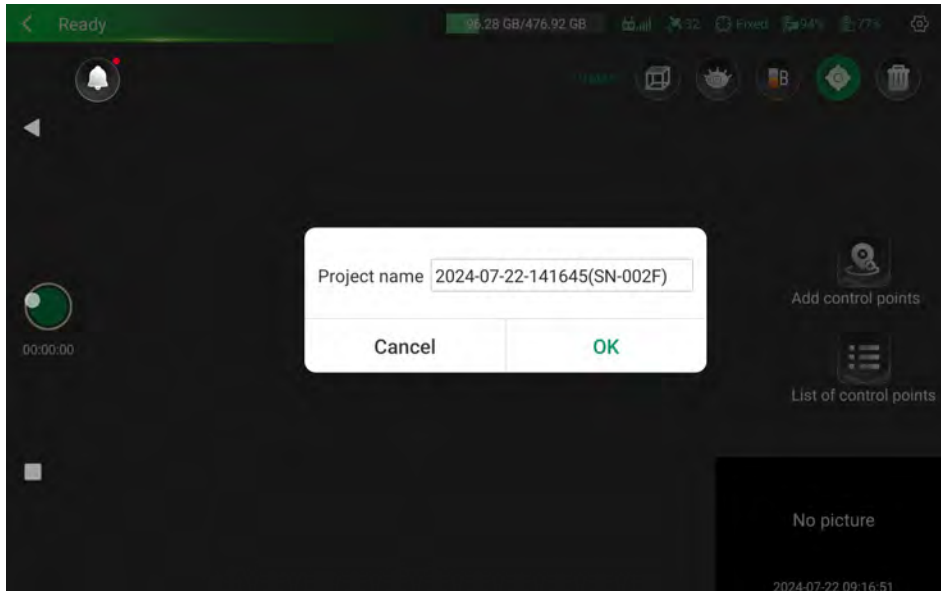

### 4.2.4 Select capture scene

- After creating the project, select the appropriate capture scene based on the environment, and proceed with data collection within the chosen scene.

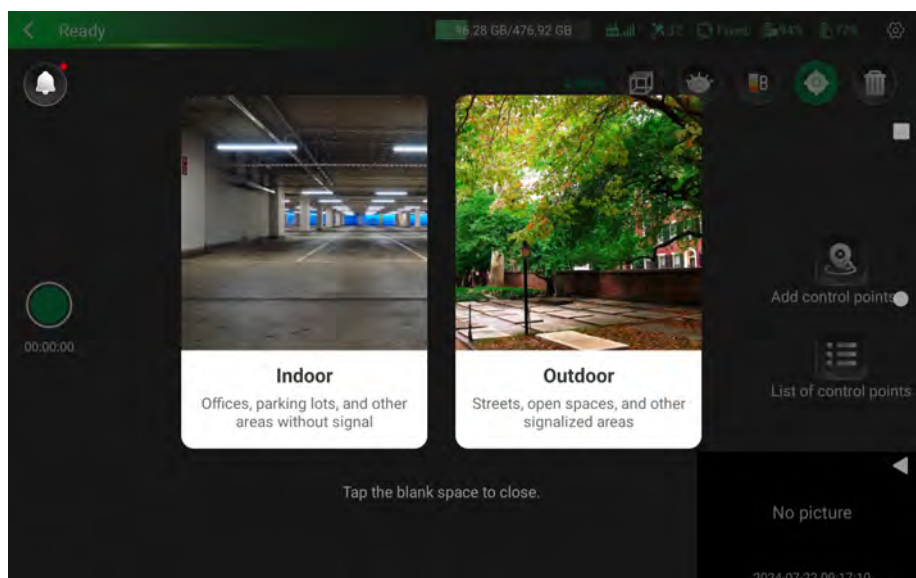

## 4.2.5 Device initialization

- Initialization starts automatically after selecting capture scene. Be sure to keep the device stable and ensure no obstructions to the scanner.

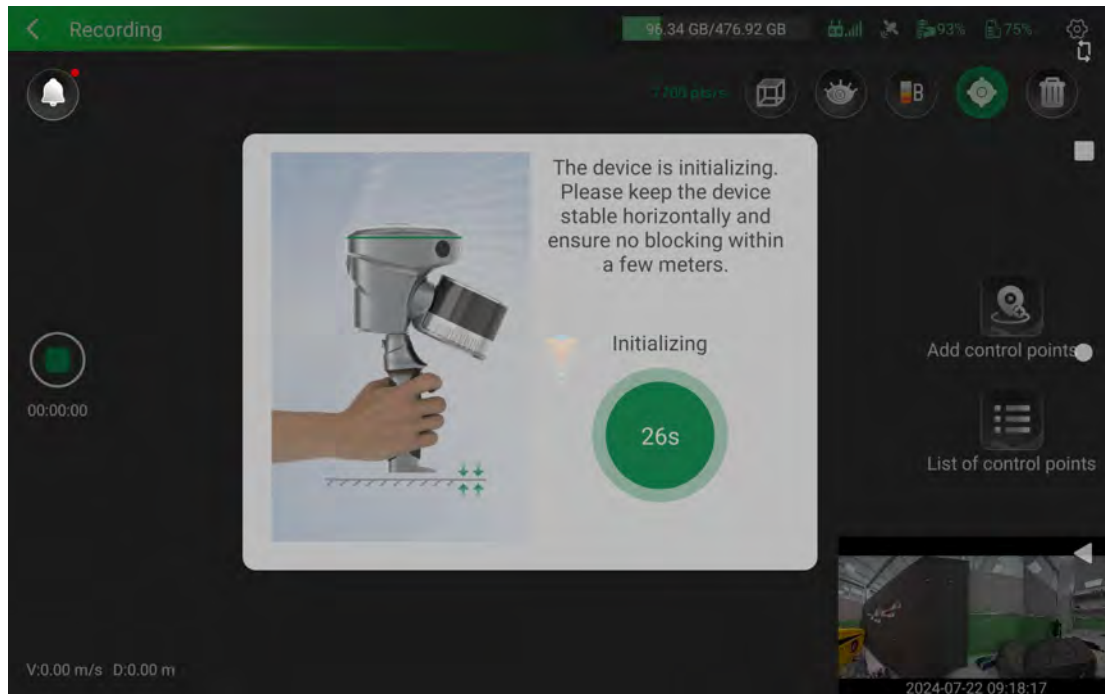

**Note:**

You'll want to aim it at a scene with lots of features, like buildings or uneven rocks. And watch out for moving objects or obstacles that could block these features. Try to minimize scanning highly reflective surfaces, like glass facades or car windows, to reduce noise in your data.

### 4.2.6 Start data acquisition

- After the initialization is successful, the device will enter the capture interface, where real-time point cloud and live captured images will appear, which means the device has started data collection automatically.

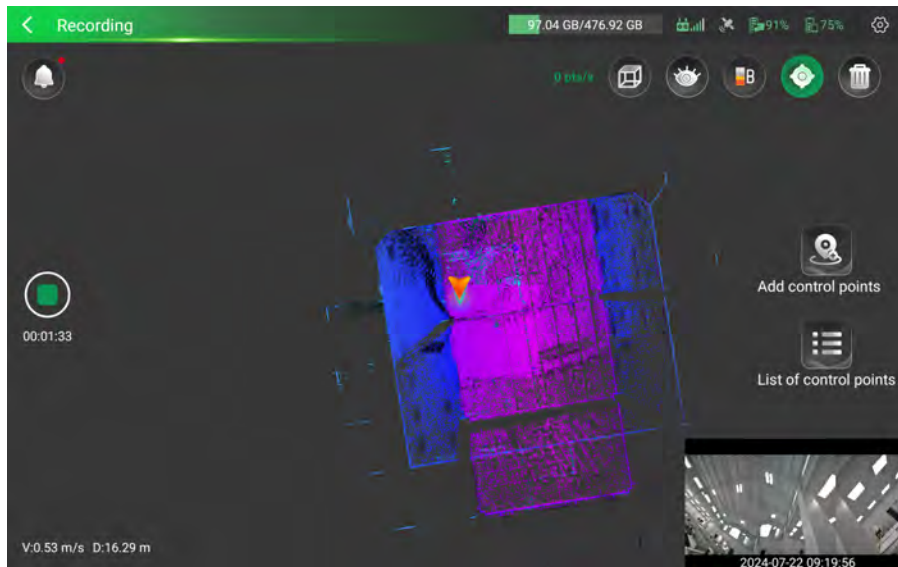

### 4.2.7 Add control point

- You can add some control points during the data collection. First, align the metal tip of the device's handle with the desired control point. Then click "Add control Points," select the corresponding operation mode, input the control point number, and click "OK" to add the control point.



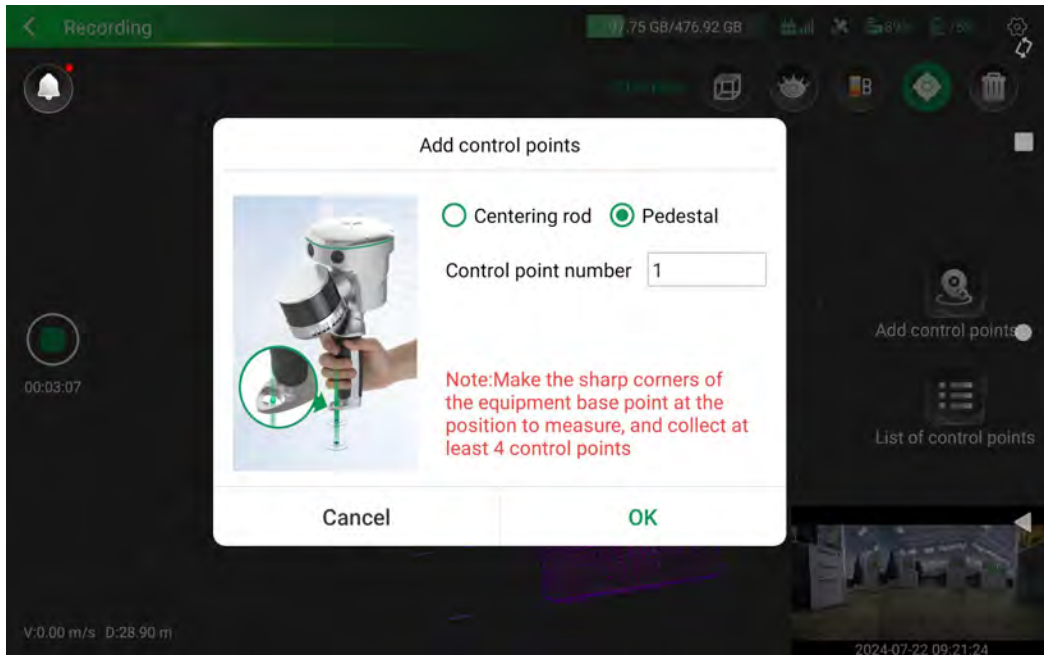

 **Note:**

If you're using the range pole mode, you'll need to input the pole height. That's not necessary for handheld or chest support modes.

Also, try to keep your control point names consistent, and remember, if you're doing coordinate conversions, you'll need at least four control points.

## 4.2.8 Stop data acquisition

- Click on the green circular button on the left side of the screen to stop data acquisition.

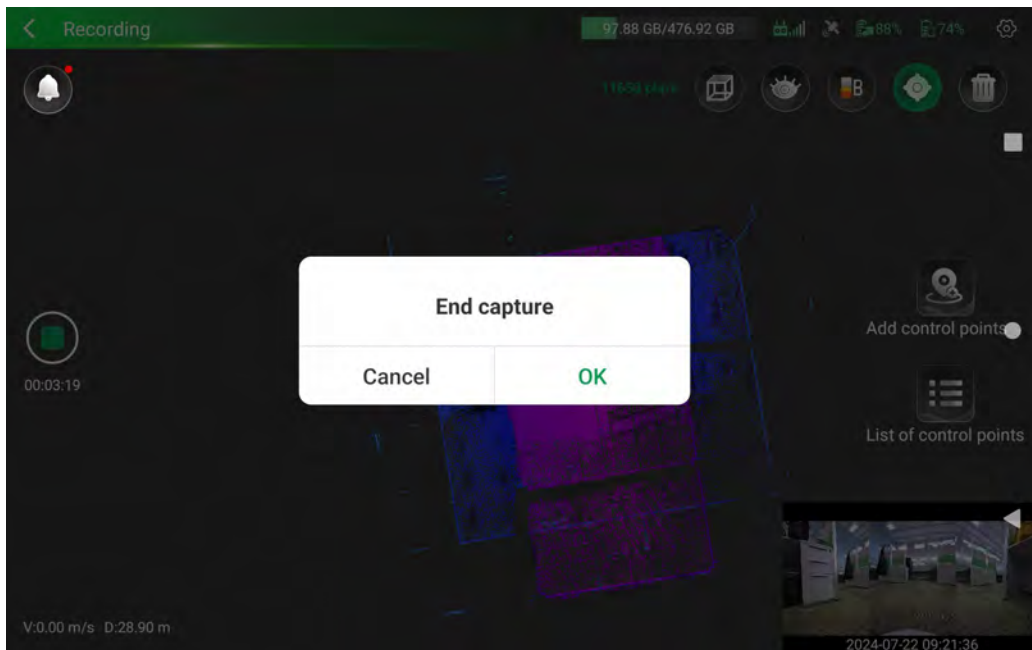

### 4.3 One-Key control

The TrueView GO is embedded with one-key acquisition software, equipped with one button (including a LED indicator), the TrueView GO can be controlled by a single key to complete data collection.

 **Note:** In One-Key control mode, you cannot select the capture scene, which defaults to indoor scene. CORS account login is not available.

- TrueView GO Power On: Long press the device's "ON/OFF key" for 5s, the indicator light is green, which means the lidar is powered on successfully.
- Device diagnostics: 5s after powering on, the device enters diagnostic mode, with the green light flashing rapidly at 2Hz. If no issue is detected in device diagnostics, the green light will be steady on.
- Start project: Short press the device's "ON/OFF key" to start project, the green light remains steady on.
- Device initialization: Initialization starts automatically, laser rotation indicates that the device is initializing. Please keep the device stable and ensure no obstructions around.
- Start data acquisition: After the initialization is successful, the device will start data collection automatically. At this moment, the green light is flashing slowly at 0.5Hz.
- Stop data acquisition: Short press the device's "ON/OFF key" to stop data acquisition.
- TrueView GO Power Off : Long press ON/OFF Key or 5s to turn off.



## 4.4 Hot-swapping battery

The TrueView GO battery compartment can only accommodate one battery at a time, but it is equipped with super capacitors internally, enabling support for hot-swappable battery replacement. During the data collection, when hot-swapping batteries, it is essential to note that after removing the battery, a 60-second battery replacement reminder interface will appear on the tablet.

 **Note:** It is necessary to complete the battery replacement within 60 seconds while ensuring that the device's position and orientation remain consistent before and after the battery replacement.

## 5 Data Processing in LP360 Land

### 5.1 Data copy

You just need connect the TrueView GO to a PC with a TYPE-C adapter cable, then copy the data you need.

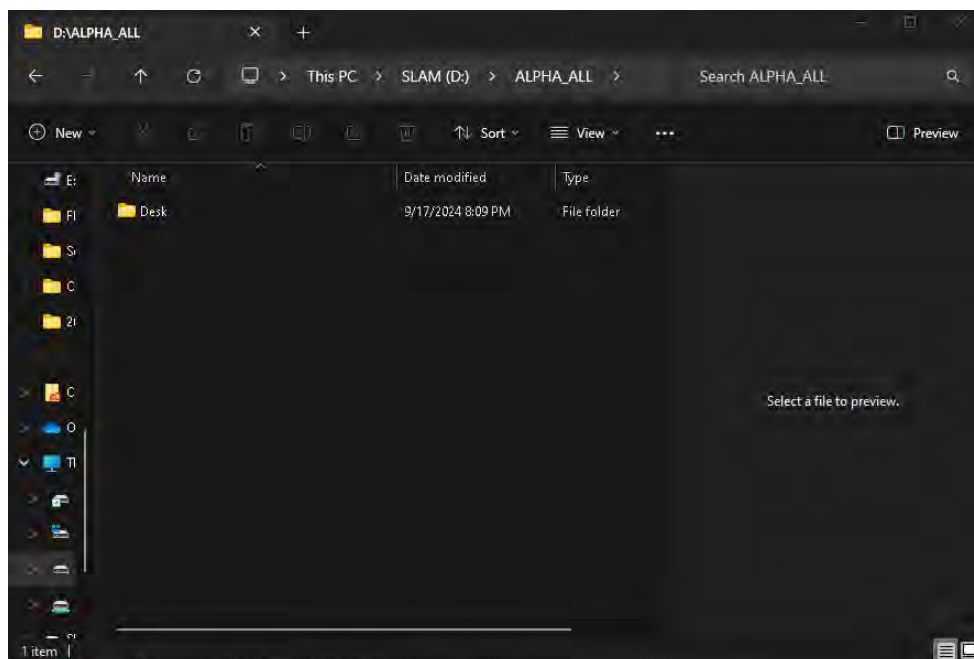

 When copying data, it is necessary to turn off the device, otherwise the computer won't recognize the device disk.

 **Note:** If the disk memory is less than 10% or cannot meet storage requirements, the user needs to free up disk space in advance.

## 5.2 Open LP360 Land

1. The screenshot below will appear
2. Select “Import Raw Missions to new Project”
3. Click on “OK”

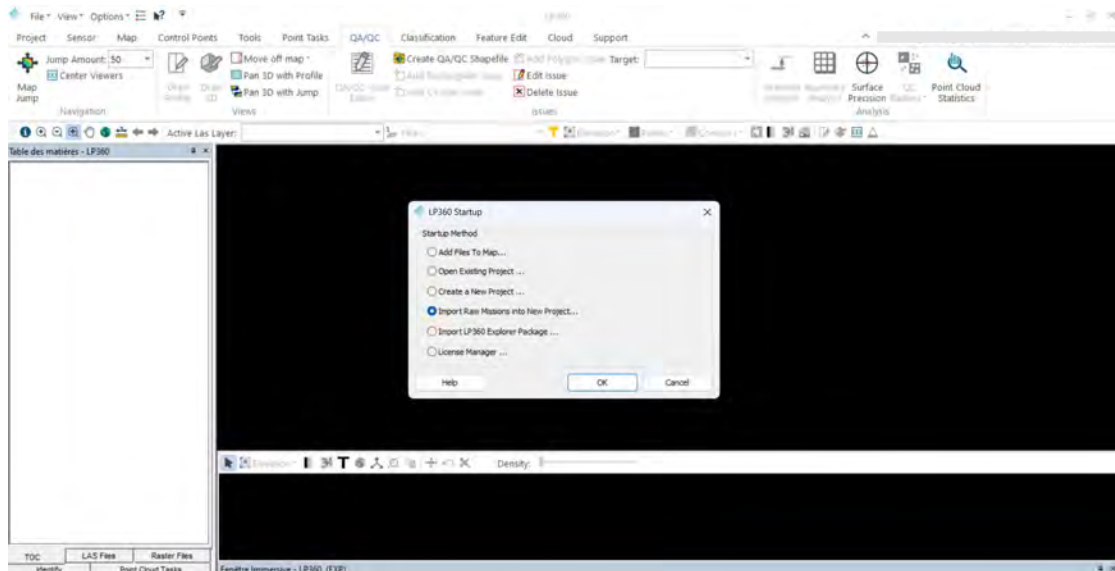

4. Select TrueView GO
5. Click “Next”

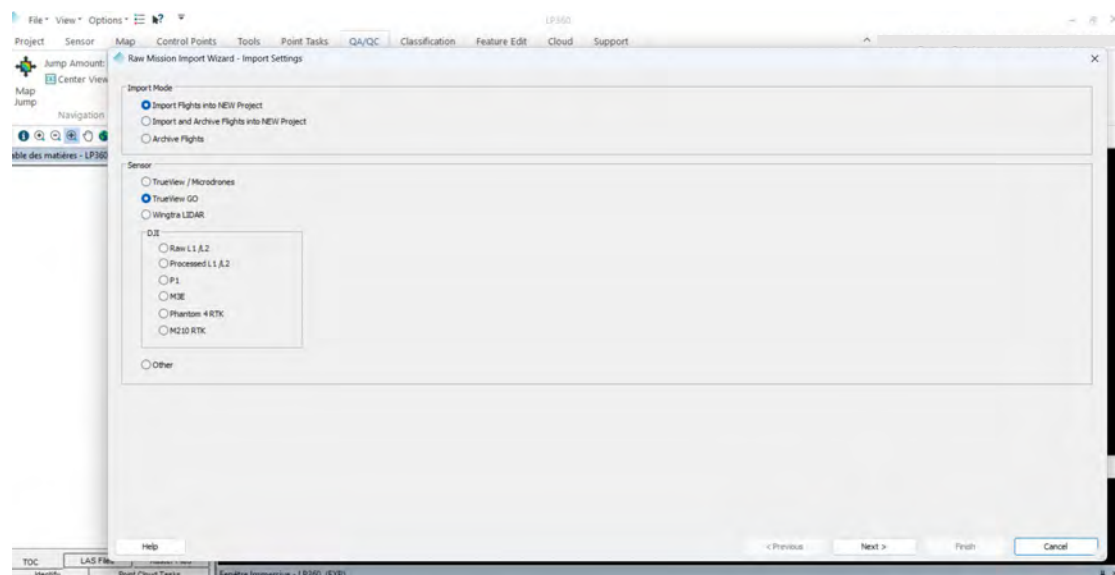

6. Screen will appear below
7. Click “Add Cycle”

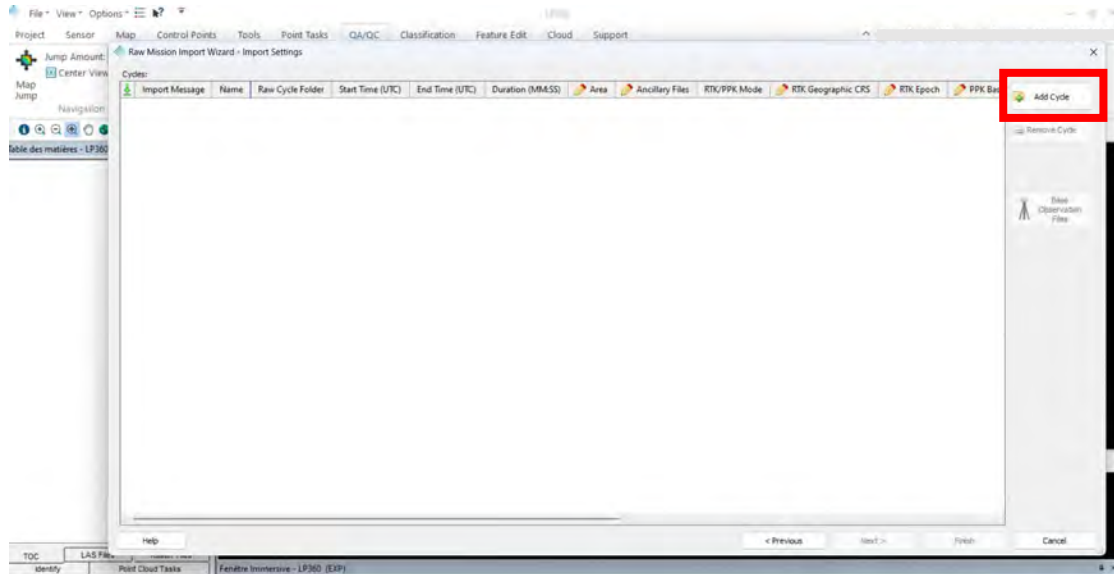

8. Select the file with the raw data you want to process
9. Click on “Select Folder”

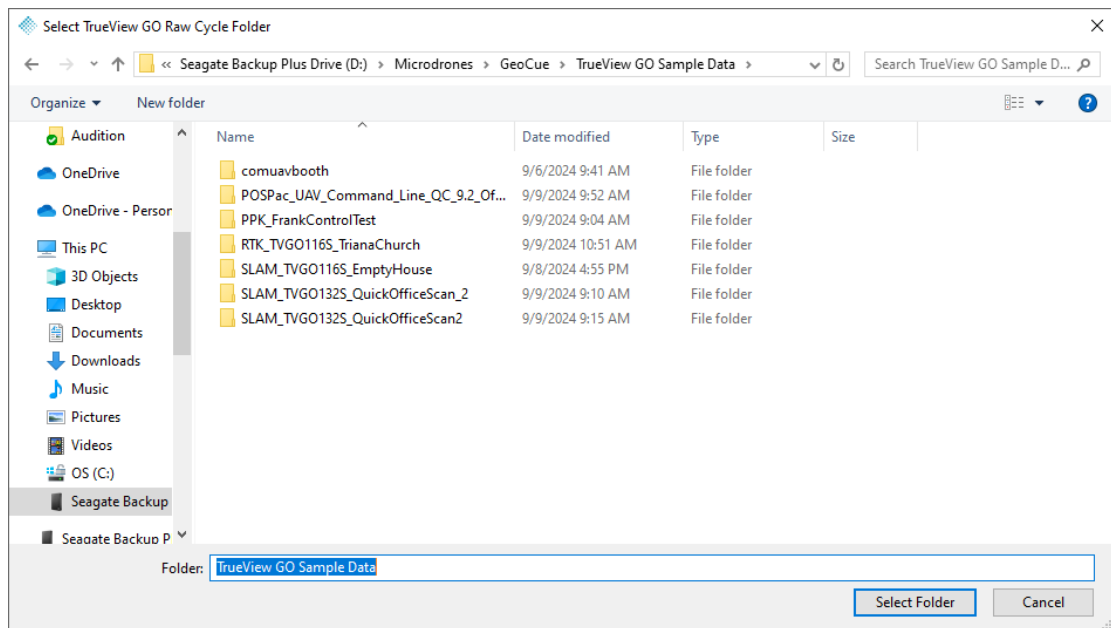

10. When the screen below appears, select “RTK/PPK/SLAM” mode

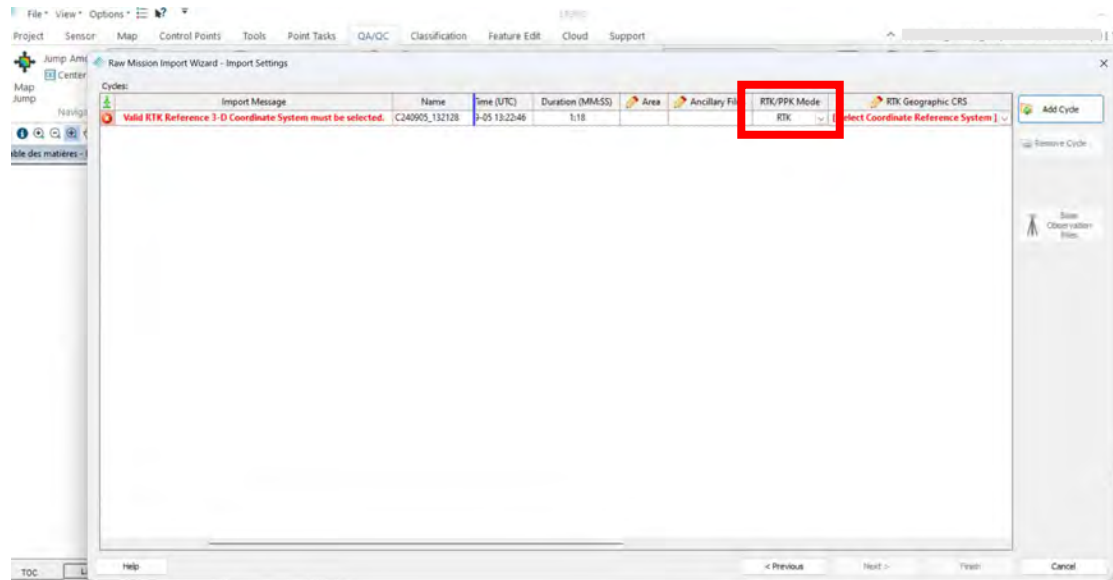

11. Select your coordinate system

12. Click “Next”

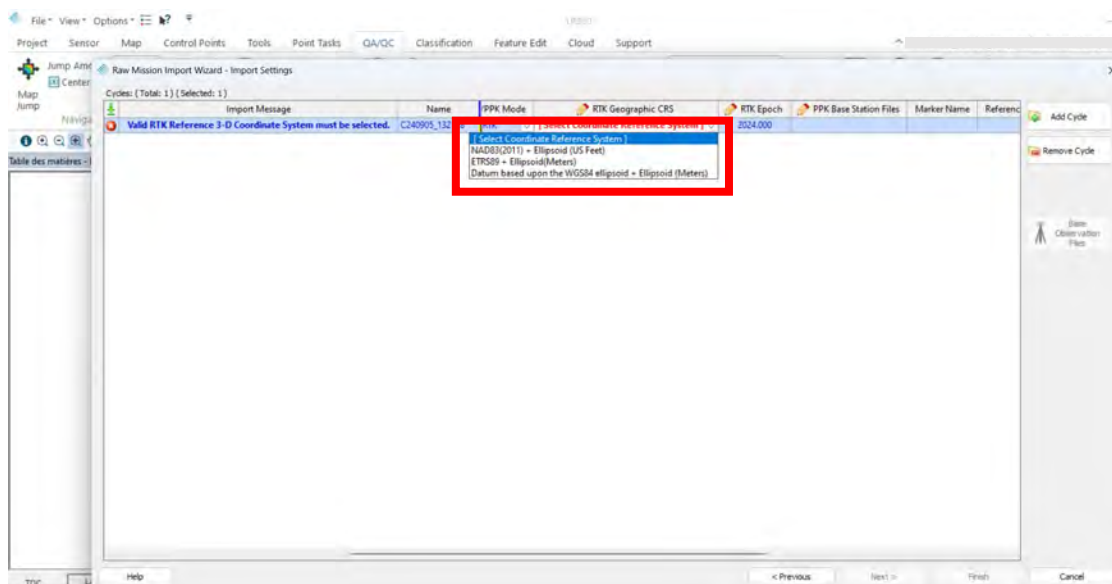

13. Indicate the TrueView Output project name
14. Select the Project Coordinate Reference system
15. Click “Next”

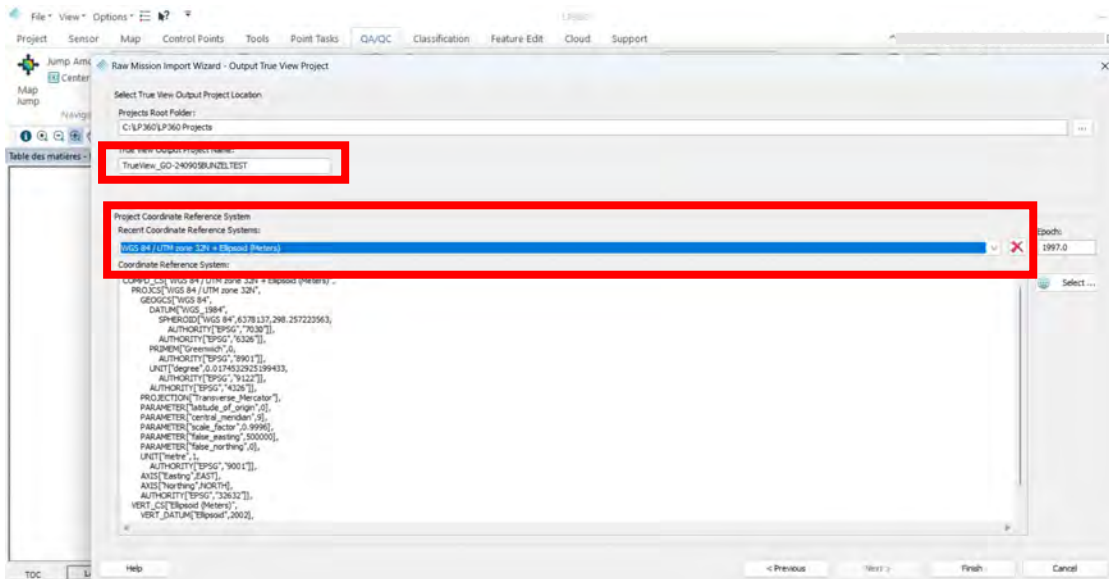

16. Data will now be imported

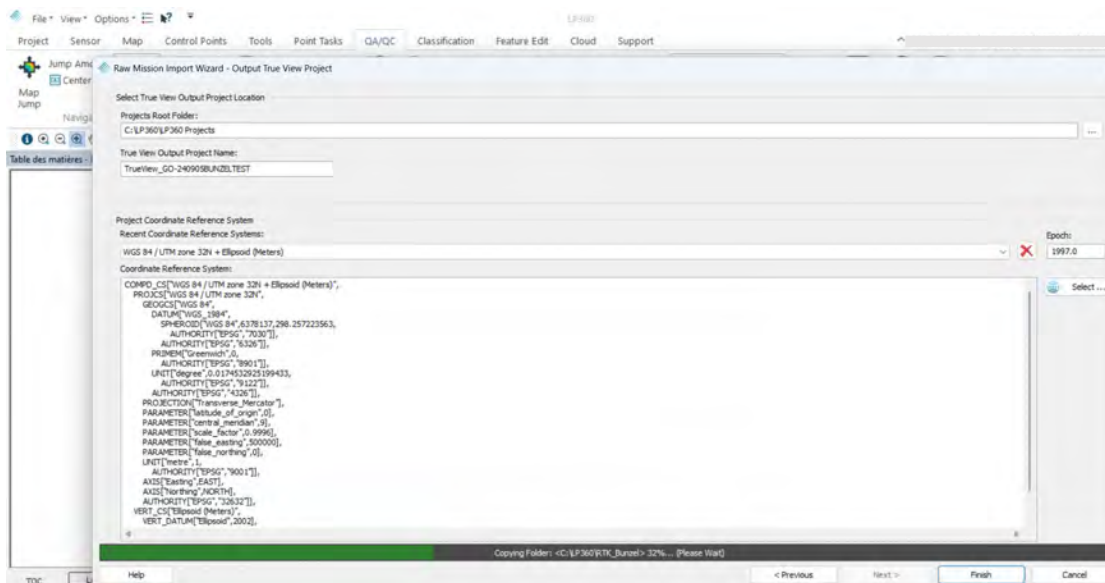

17. Once imported, click on the “Job Manager”

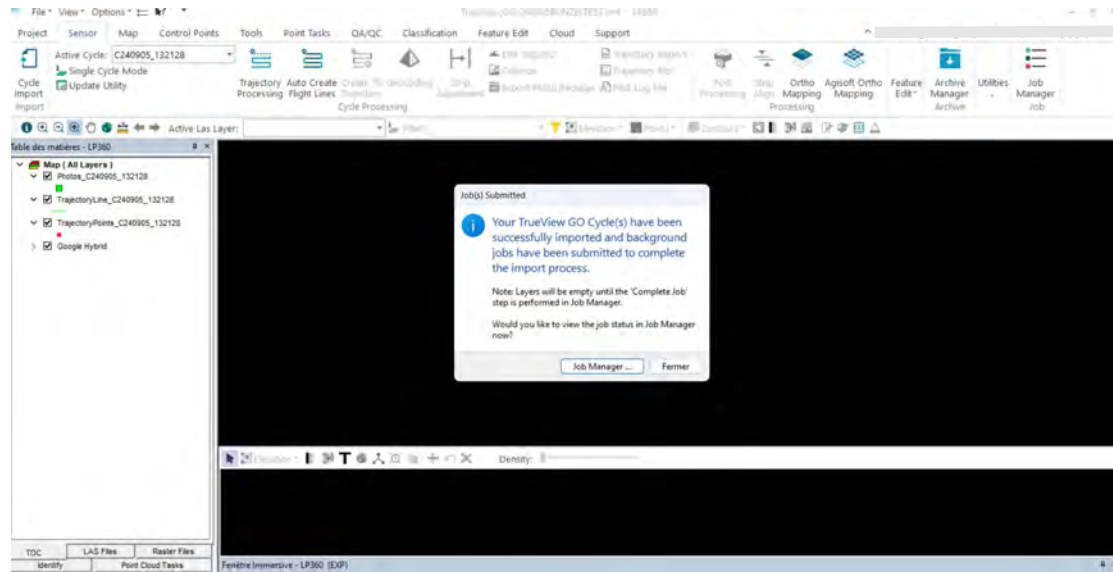

18. The Job Manager progress screen will appear

19. Duration will depend on your project size

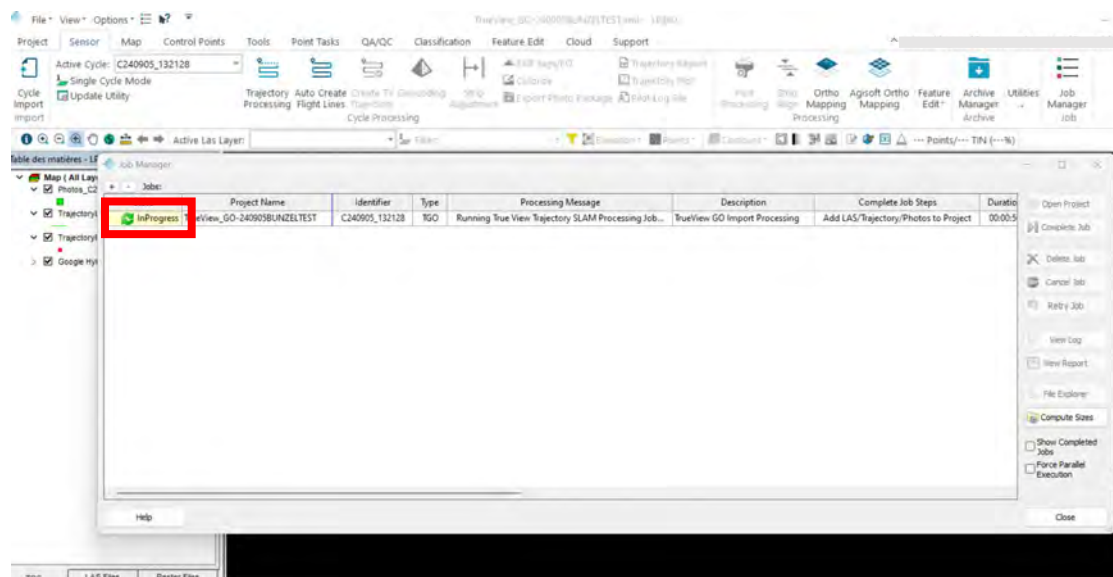

20. Upon completion the “Ready” message will appear

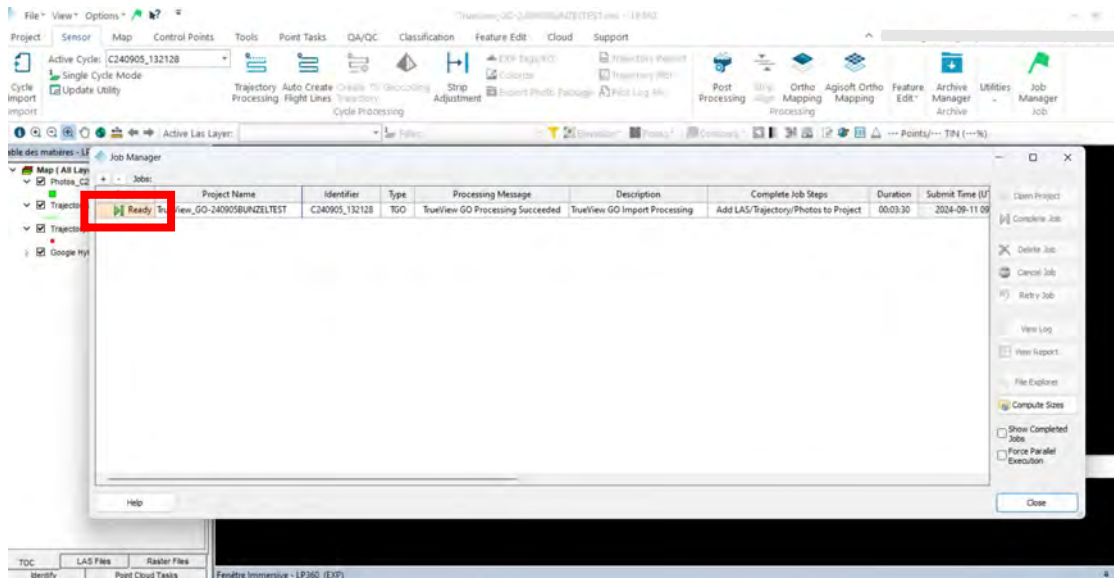

21. Select the project (you can have multicyle processing launched if you use LP360 Land Standard

22. Click on “Complete Job”

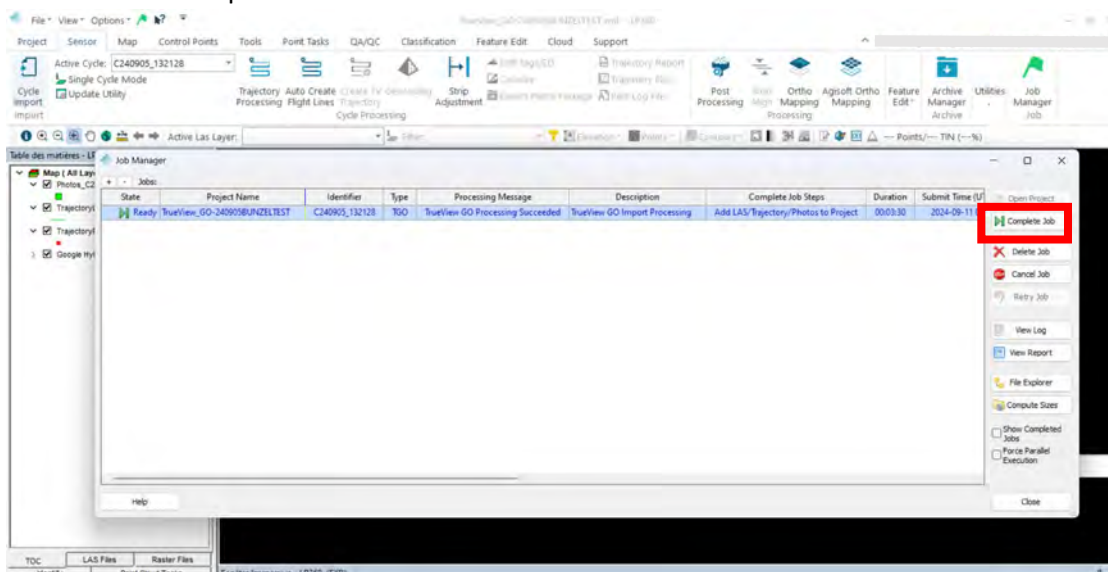

23. Click on “Yes”

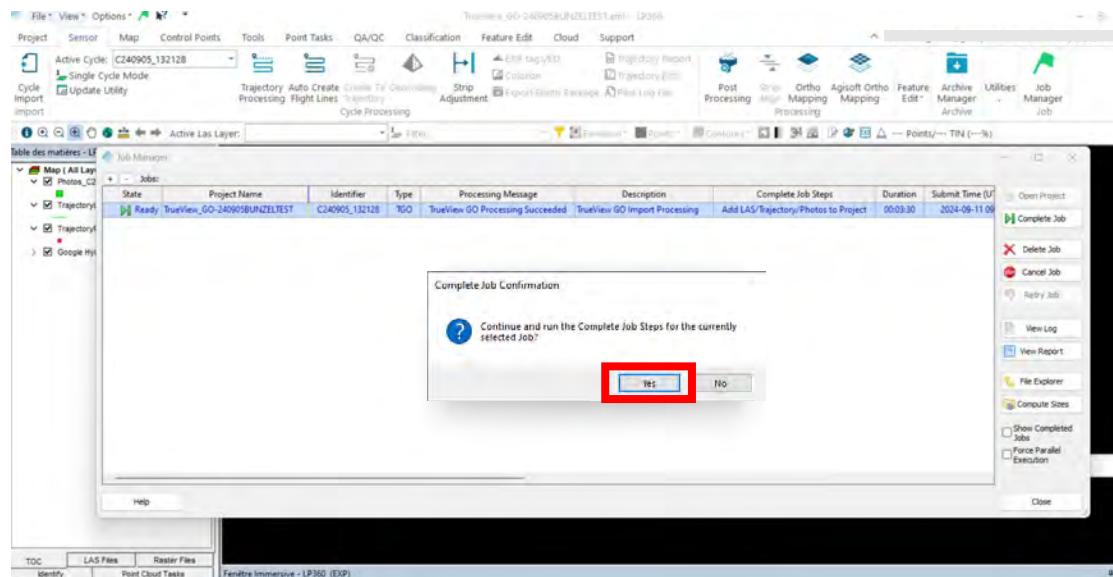

24. On the next screen click on “Post Processing”

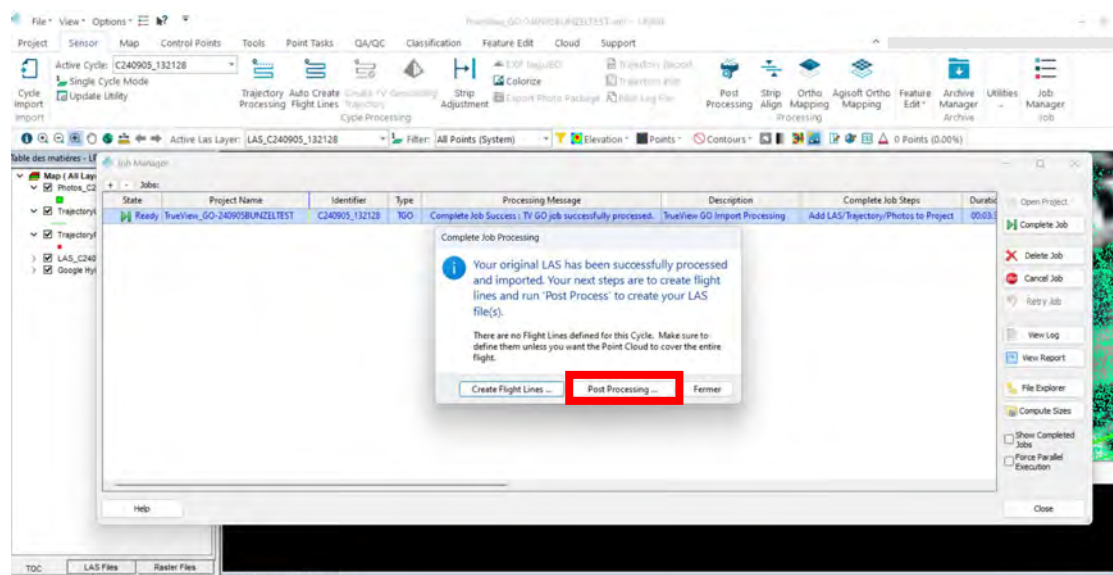



25. Select the cycle
26. Click on “Run Post Processing”

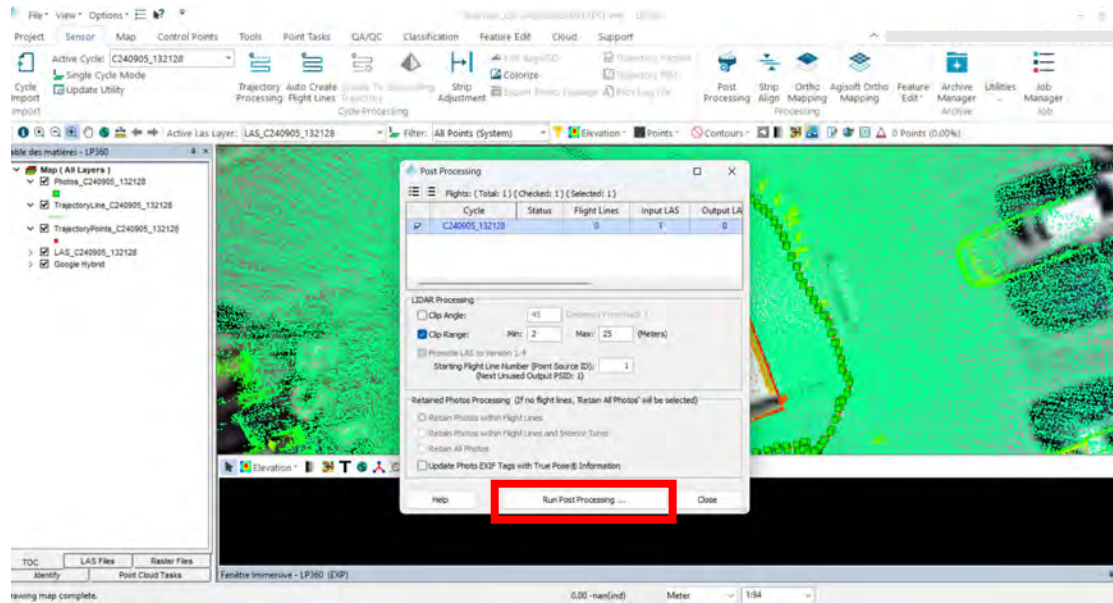

27. Your LAS file will now be ready
28. To use the Immersive View, click View and select Immersive Viewer

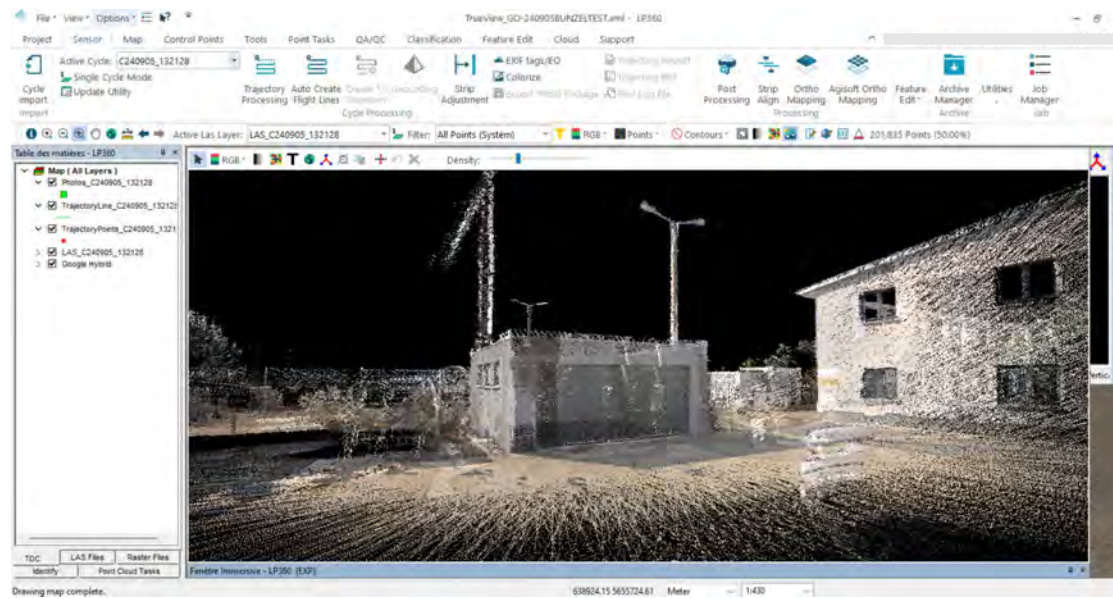

## 6 Matters Needing Attention

### 6.1 Important Notes

▪ The LiDAR measurement system is a complex and precise surveying tool. To ensure its proper functioning, please handle, use, and store the equipment correctly and maintain it properly. Here are some important notes:

- Do not disassemble the equipment yourself. If there are any issues, please contact the GeoCue support team.
- Please use the default battery and accessories. Using a non-dedicated battery may cause the charger to explode or burn. The use of non-original accessories will void the warranty.
- When using the charger, keep it away from fire, flammable, or explosive materials to avoid serious consequences such as fire
- Avoid any strong impact or vibration.
- If you need to use the instrument for an extended period or under special conditions such as high humidity, please consult the GeoCue Support team for relevant precautions in advance. Generally, damage that occurs under such special conditions is not covered by the product warranty.

### 6.2 Product Transportation

- The GeoCue TrueView GO product comes equipped in a special container. During transportation, make sure the container is fixed in a stable location.
- During transportation, inform the relevant personnel that this is a container for a precision system and must be handled gently. Additionally, attach a "fragile" label to the container.
- If the equipment is being sent by express service, ensure the container is placed inside an outer box with foam padding for added protection.
- When transporting or moving batteries, take proper precautions to prevent them from falling or getting damaged.

### 6.3 Using Tips

- Handle the equipment gently during use to avoid soiling or scratching its surface. It is strongly recommended not to sit on the container.
- Avoid long-term storage. The equipment should be taken out regularly (approximately once a month) for a power-on test to ensure it is functioning normally.
- If any rotating parts of the equipment are difficult to turn, do not force them. If the equipment is damaged, discontinue use immediately to prevent further damage. Do not

disassemble the equipment in the field.

- If you encounter rain or snow while working in the field, quickly move the equipment into its container.

## **6.4 Storage Tips**

- The room where the equipment is stored should be clean, dry, bright and well ventilated.
- It should be placed flat or upright, and it should not be leaned casually to prevent distortion.



**GEOCUE**

520 6th Street Madison, AL 35756

1-256-461-8289

[www.geocue.com](http://www.geocue.com)